

made in germany



Qompact
Roller Shutters





Alulux Qompact roller shutters provide a complete system that increases security, prevents break-ins and protects against the elements. The very small roller shutter box measuring just 165 mm at an element height of 2.60 m enables subtle solutions.

Indoor use is also possible: Qompact roller shutters are mainly used outdoors but are also increasingly applied indoors. In this case, the system is installed indoors directly behind the inner lintel or wall opening as burglary and entry protection. Indoor assembly thus provides users with additional protection within premises. Qompact roller shutters are ideal as an added door and patio security device. A complete system made of high-quality aluminium.

Unobtrusive

The roller shutter box is considerably smaller than many boxes available on the market. Box and profiles made of extruded aluminium

Optimum security

Qompact roller shutters are the ideal burglary system for front and basement doors and windows.

Variable

Depending on the customer's requirements, Alulux Qompact roller shutters can be equipped with punched or un-

punched roller shutter profiles. Furthermore, three box types are available.

Robust, factory tested

The single-skinned aluminium profile is extremely robust as it is extruded. This increases burglary protection and protects against extreme weather conditions.

Product service life

All roller shutter components are designed for long service life with minimum maintenance.

Colours

Alulux roller shutters can be individually powder coated to match the colour of the facade.

Available standard colours



Traffic white RAL 9016, White aluminium RAL 9006, Anthracite grey RAL 7016. Special colours in RAL for an extra charge.

Box types



Box sizes = element heights with aluminium Q profile

Box size 150 mm	=	Element height 2.10 m
Box size 165 mm	=	Element height 2.60 m
Box size 180 mm	=	Element height 3.00 m
Box size 205 mm	=	Element height 3.60 m
Max. element height 3.60 m, max. element width 4.60 m		

60% smaller box:

1. Roller shutter box with locally manufactured steel slats, element height 3.00 m
2. Qompact roller shutters with extruded aluminium Q profile Element height 3.00 m **60% smaller box**

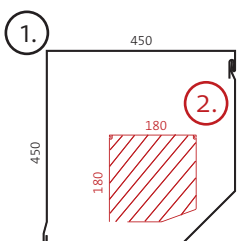

Alulux Qompact roller shutters offer increased security

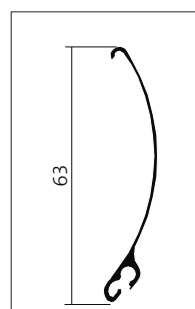
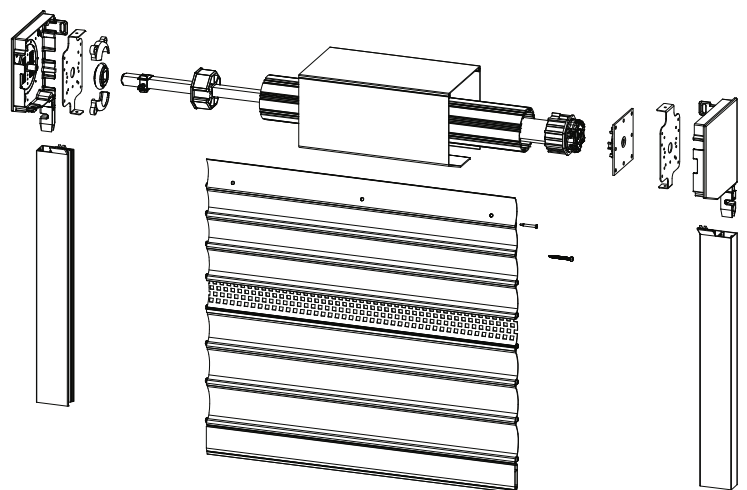

Extruded aluminium Q profile, example profile no. 4

SHUTTERS



Burglary protection



Storm tested



Sun protection



Weather protection

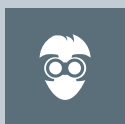

Privacy protection



Entry control



Additional indoor protection

Do the **CHECK**

and make sure all the critical points of your house are protected by Qcompact roller shutters:

Check 1: Patio door secured?

Check 2: Basement door secured?

Check 3: Side entrance door secured?

Check 4: Access to loggia, garden shed secured?

Check 5: Windows secured?

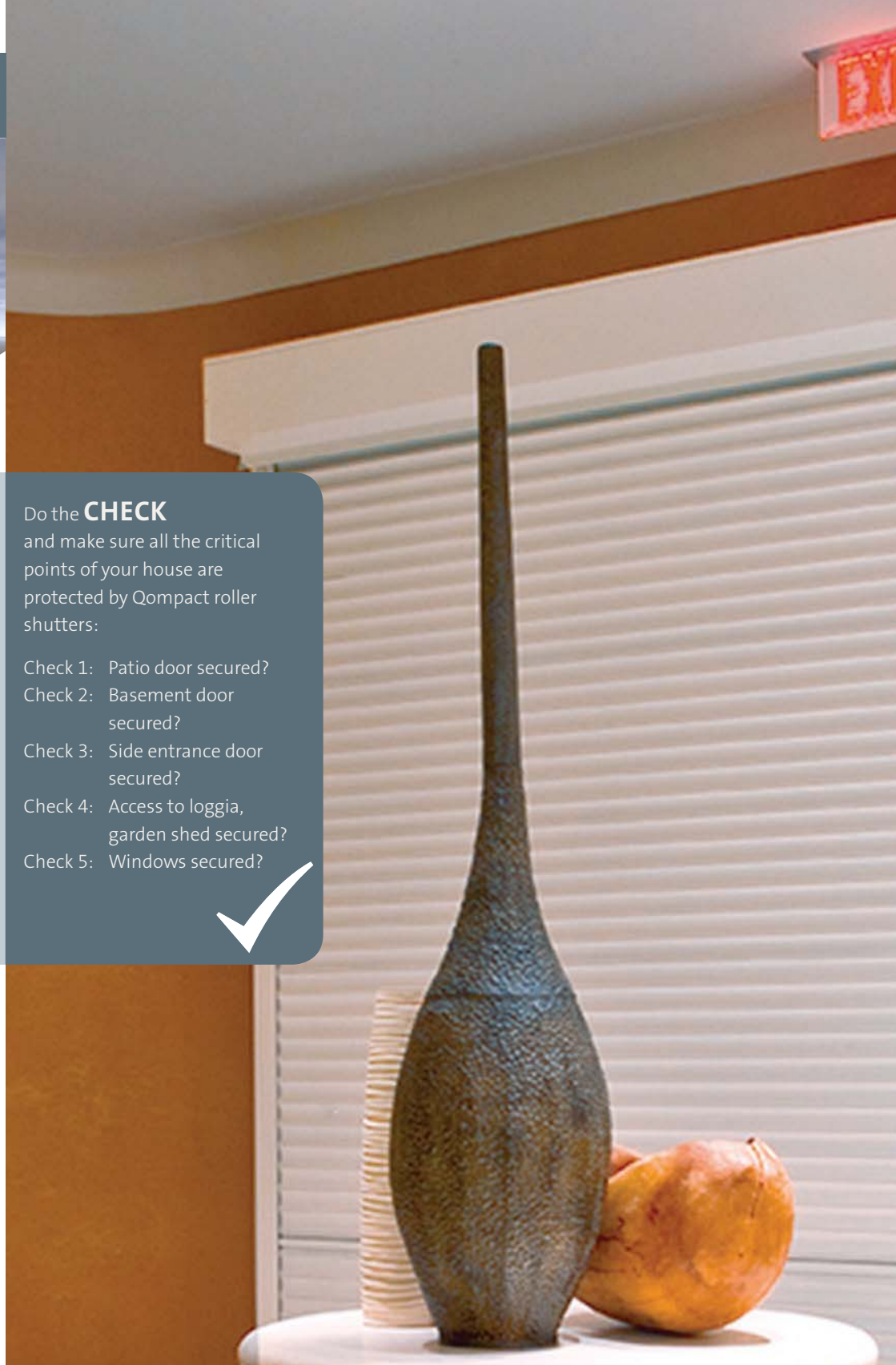

Advantages

- Small extruded roller shutter box
- Effective burglary protection
- Impact resistant, shockproof
- Storm tested
- Secured by a motor brake against being forced open
- Motor operated as standard

Facts

- Unique winding properties of the roller shutter - very tight winding, resulting in an unobtrusive box
- Fully extruded system; optimum security, strong material
- Powder coated surface; best surface and weather protection.
- Secured via Q-XL security side locking; against being levered out of the lateral guide channel
- Sealed and punched profiles can be combined; offering great visual diversity



At a glance - good reasons for choosing Alulux Qcompact:

- Very tight winding - very small box = almost unlimited application options!
- 90% aluminium = no corrosion!
- Ultra-strong extruded aluminium profiles = impact resistant and almost indestructible!
- Sealed profiles = no risk of burglars spying into your property, thus increasing security!
- Punched profiles = can be used in front of shop windows = providing viewing access to people outside while enhancing security!
- Sealed and punched profiles can be combined = offering great visual diversity and security!
- Secured by a motor brake against being forced open = helping to make your premises impenetrable!
- Extruded aluminium box = strong and impact resistant!
- Three box types = 20 degrees, 90 degrees, round = therefore suitable for every style of building!
- Deep extruded aluminium guide channels with safety latch and security side locking made of galvanised steel = it is thus almost impossible to prise open the curtain!
- Invisible attachment of the guide channel = enhances security and looks good!
- Hurricane tested up to approx. 300 km/h = therefore also suitable for application in regions where storms are common!
- Highest quality RAL powder coating for the profiles = long service life, reduced wear!
- Four standard colours = also for boxes and guide channels!
- Highest quality facing caps made of diecast aluminium = no corrosion!
- Special attachment inside the facing caps = no visible screws
- Special ball bearing, secured against being forced open = enables smooth and even operation = no unwanted noises!
- Special aluminium shaft = ensures optimum winding of the profiles
- Use of high-quality motors = easy operation and long service life!

ALULUX®

www.alulux.com

Qcompact roller shutters

Front-mounted roller shutters. Increased safety

SG 20 | SG 90 | SGF system
Extruded aluminium box

Manufactured to DIN EN 13659.



Box sizes

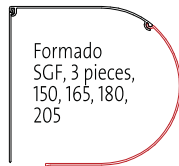
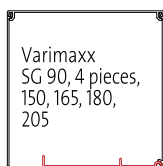
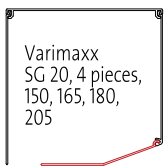

Extruded aluminium roller shutter box



Roller shutter box made of extruded aluminium, basic equipment, 4 pieces, including back.



1/2 round roller shutter box made of extruded aluminium, 3 pieces, including back.

Extruded aluminium Q profile, example profile no. 4

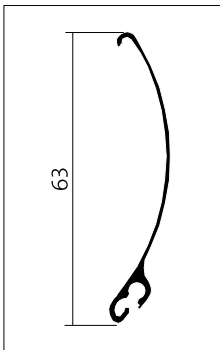

Usable roller shutter slats



Q profiles,
 extruded aluminium roller shutter profiles

Ready made units with motor

The standard motor is a Somfy drive, with electronic end stop.

Alulux always chooses the smallest possible box size. If a different configuration is required, please specify this accordingly on your order.

Box sizes Alulux Qcompact (outer dimension)

Box	Height (cm)	Width (cm)																				
		80	100	120	140	160	180	200	220	240	260	280	300	320	340	360	380	400	420	440	460	
150	80																					
	90																					
	100																					
	110																					
	120																					
	130																					
	140																					
	150																					
	160																					
	170																					
	180																					
	190																					
	200																					
	165	210																				
220																						
230																						
240																						
250																						
260																						
180	270																					
	280																					
	290																					
	300																					
	310																					
	320																					
	330																					
	340																					
205	350																					
	360																					

